



Jayco[®]

Generations of family fun.

JAY FEATHER

2015 ULTRA LITE TRAVEL TRAILERS BY JAYCO



This 1986 brochure cover inspired our 2015 literature.

2
YEAR
WARRANTY

BUILT TO **expand** ON FAMILY FUN



JAY FEATHER SLX

JAY FEATHER

For 45 years, Jayco has helped create generations of family fun, and over the course of that time, fun still looks remarkably the same. From campfires to fishing, from relaxing to eating, fun has the same feel generations later—and all with a Jayco RV nearby. Today, we're the largest family-owned RV manufacturer in the world, and our promise is to continually strive to build family-friendly products that will outlast just about everything but your memories. Join us in our generations of family fun.

On the cover: The 1986 brochure artwork, illustrated by Tim MacDonald, was part of a successful ad campaign. These illustrations inspired the 2015 Jayco brochure covers, which are live re-creations of Tim's artwork.



Scan this QR code to watch how Jayco has delivered Generations of Family Fun or visit www.GenerationsOfFamilyFun.com.

Part travel trailer, part Swiss army knife, the 2015 Jayco Jay Feather is packed with everything your family needs in an ultra lite, expandable design, meaning you can live large, tow small and fold out for loads of fun.

AT THE CAMPSITE

Jay Feather is a hybrid model, blending the comforts of a hardwall travel trailer with all the fun that tent camping provides. Our tent system sets up in four easy steps.



- 1** Unlatch the bed platform.
- 2** Guide the bed platform down (far left).
- 3** Insert the bed bow brace (left).
- 4** Make the bed!



close for towability [Travel-friendly lengths]

open for amenities [More standard features]

ON THE ROAD

When it's time to pack up, room-making tent ends fold in for a more compact design. Jay Feather's travel-friendly lengths and legendary lightweight floorplans make this travel trailer towable by most minivans, crossovers and SUVs.* Independent rubberized suspension and E-Z Lube axles complete this towable package.

* Consult with your authorized automobile manufacturer or vehicle owner's manual; some models require a tow package.



JAY FEATHER SLX 18SRB

Jay Feather SLX

Fun-sized for families

Jay Feather SLX makes it fun to live lightly. Weighing in under 3,330 pounds, our newest (and lightest) Jay Feather is towable by most minivans and crossovers,* delivering everything you need for your next on-the-go adventure.

* Consult with your authorized automobile manufacturer or vehicle owner's manual; some models require a tow package.



JAY FEATHER SLX 16XRB



JAY FEATHER SLX 16XRB



JAY FEATHER SLX 16XRB

THE SUPER TOWABLE SLX



TRAVEL LENGTH

18' 4"-21' 10"



WEIGHT

2,540-3,330 lbs.



SLEEPS

3-8



MINIVANS*

MAKE	MODEL	ENGINE
Honda	Odyssey	3.5L V-6
Toyota	Sienna**	3.5L V-6
Nissan	Quest	3.5L V-6
Kia	Sedona	3.5L V-6
Dodge	Grand Caravan**	3.6L V-6
Chrysler	Town & Country**	3.6L V-6



CROSSOVERS

MAKE	MODEL	ENGINE
Ford	Flex	3.5L V-6
Chevrolet	Traverse FWD/AWD**	3.6L V-6
GMC	Acadia**	3.6L V-6
Toyota	4Runner	4.0L V-6

* Tow rating matches the GVWR of the 16XRB and 18FDB models only

** Towing package required

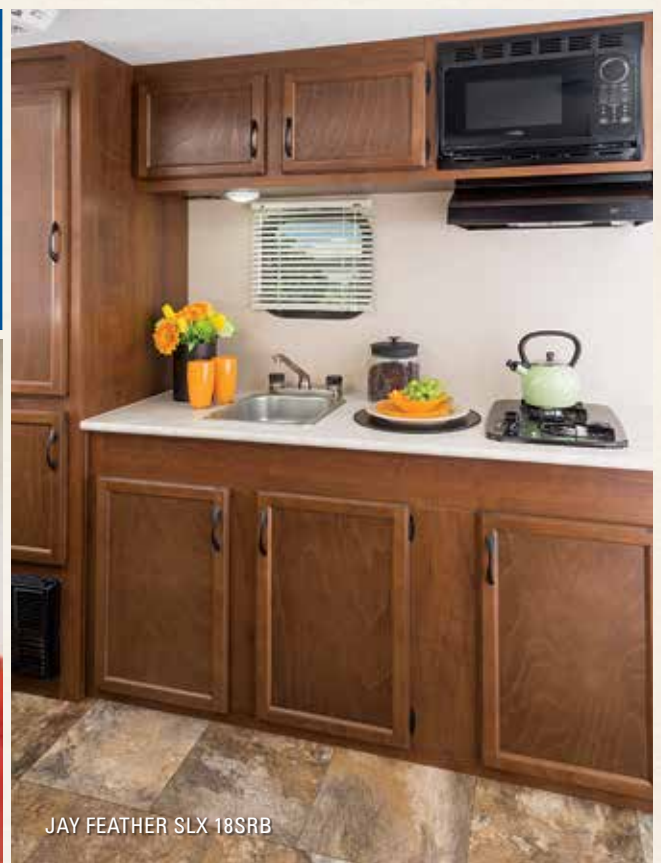

JAY FEATHER SLX 18SRB



JAY FEATHER X23B | BRICK

Jay Feather

Fold out for fun

The 2015 Jay Feather lineup is bursting with space-making floorplans. From full-featured kitchens to family-friendly dinettes, from multiple tent ends to a select model king bed slideout, Jay Feather is redefining the lightweight category with its wall-to-wall features.



JAY FEATHER X17Z | TRUFFLE



JAY FEATHER X23B | BRICK



MOTHER NATURE APPROVED

Jay Feather tents feature a vinyl material that packs up well and resists mold, mildew, scratches and cracks. Plus, when Mother Nature puts up a fuss, enjoy the spacious interiors with the tents closed.



JAY FEATHER X23B | BRICK

JAY FEATHER X17Z | TRUFFLE

JAY FEATHER SLX FLOORPLANS

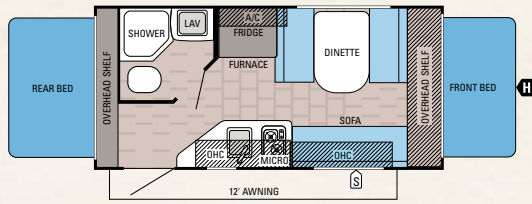

JAY FEATHER SLX | 16XRB

Ext. Length: 18' 4" Ext. Height: 117" Unloaded Wt. (lbs.): 2,540 Sleeps: 6-7

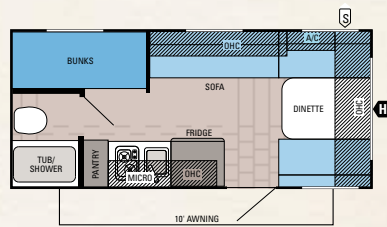

JAY FEATHER SLX | 18FDB

Ext. Length: 20' 6" Ext. Height: 117" Unloaded Wt. (lbs.): 2,595 Sleeps: 4-5

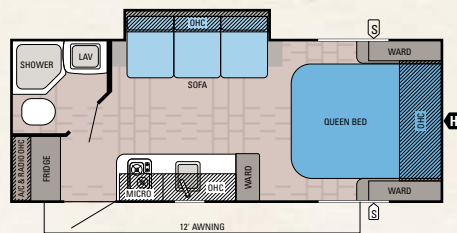

JAY FEATHER SLX | 18SRB

Ext. Length: 21' 10" Ext. Height: 117" Unloaded Wt. (lbs.): 3,115 Sleeps: 3-4

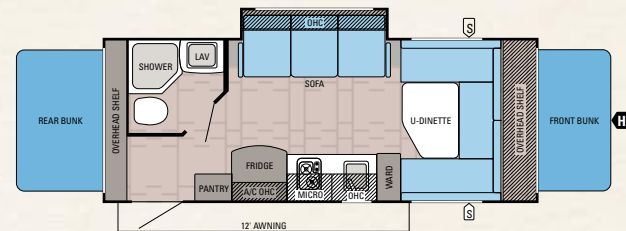

JAY FEATHER SLX | 19XUD

Ext. Length: 21' 10" Ext. Height: 117" Unloaded Wt. (lbs.): 3,330 Sleeps: 6-8

JAY FEATHER ULTRA LITE FLOORPLANS

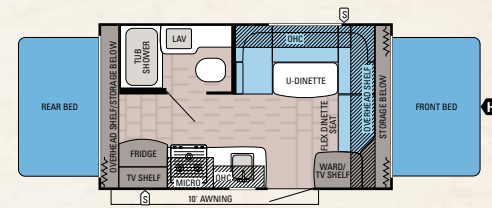

JAY FEATHER ULTRA LITE | X17A

Ext. Length: 18' 7" Ext. Height: 116" Unloaded Wt. (lbs.): 2,780 Sleeps: 5-6

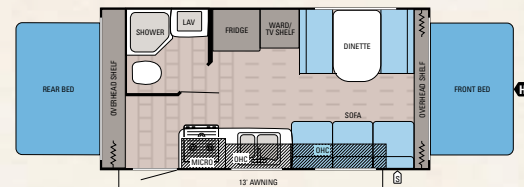

JAY FEATHER ULTRA LITE | X19H

Ext. Length: 20' 8" Ext. Height: 121" Unloaded Wt. (lbs.): 3,320 Sleeps: 6-8

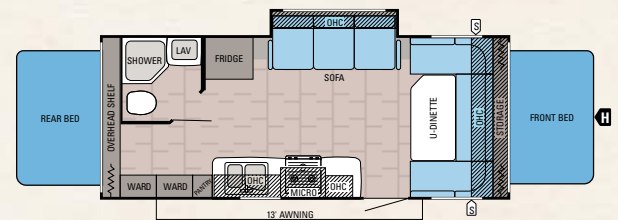

JAY FEATHER ULTRA LITE | X23B

Ext. Length: 24' 5" Ext. Height: 119" Unloaded Wt. (lbs.): 3,905 Sleeps: 7-8

- S STORAGE
- H TRAILER HITCH
- LAV BATHROOM SINK
- MICRO MICROWAVE
- OHC OVERHEAD CABINETS
- FRIDGE REFRIGERATOR
- WARD WARDROBE

JAY FEATHER SLX SPECIFICATIONS

MODELS	DIMENSIONS				WEIGHTS (LBS.)				TANKS (GALS.)		
FLOORPLAN	EXTERIOR TRAVEL LENGTH	EXTERIOR WIDTH	EXT. HEIGHT (WITH A/C)	INTERIOR HEIGHT	UNLOADED VEHICLE WEIGHT*	DRY HITCH WEIGHT	GROSS VEHICLE WEIGHT RATING	CARGO CARRYING CAPACITY	FRESH (INCLUDES WATER HEATER)	GRAY	BLACK
16XRB	18' 4"	85"	117"	78"	2,540	310	3,500	960	26	15	9
18FDB	20' 6"	85"	117"	78"	2,595	450	3,500	905	26	15	9
18SRB	21' 10"	85"	117"	78"	3,115	300	4,250	1,135	26	15	9
19XUD	21' 10"	85"	117"	78"	3,330	380	4,250	920	26	15	9

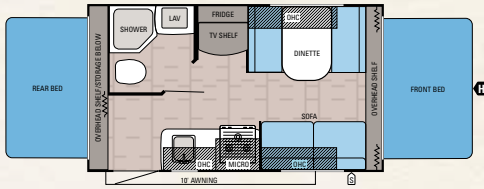

JAY FEATHER ULTRA LITE | X17Z

Ext. Length: 18' 7" Ext. Height: 116" Unloaded Wt. (lbs.): 2,785 Sleeps: 6-8

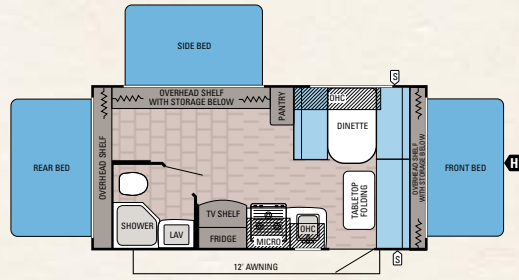

JAY FEATHER ULTRA LITE | X18D

Ext. Length: 20' 9" Ext. Height: 121" Unloaded Wt. (lbs.): 3,410 Sleeps: 7-8

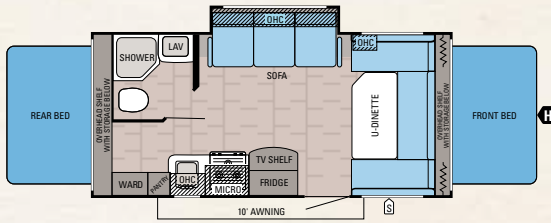

JAY FEATHER ULTRA LITE | X20E

Ext. Length: 21' 11" Ext. Height: 121" Unloaded Wt. (lbs.): 3,580 Sleeps: 7-8

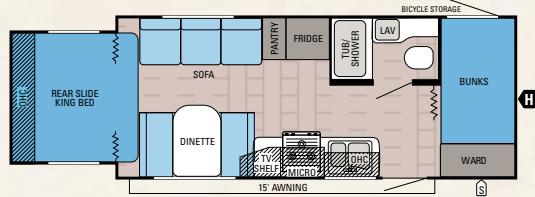

JAY FEATHER ULTRA LITE | X213

Ext. Length: 24' Ext. Height: 119" Unloaded Wt. (lbs.): 4,005 Sleeps: 6-8

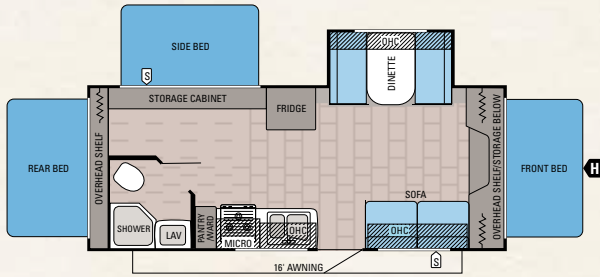

JAY FEATHER ULTRA LITE | X23F

Ext. Length: 24' 5" Ext. Height: 119" Unloaded Wt. (lbs.): 4,170 Sleeps: 8-10

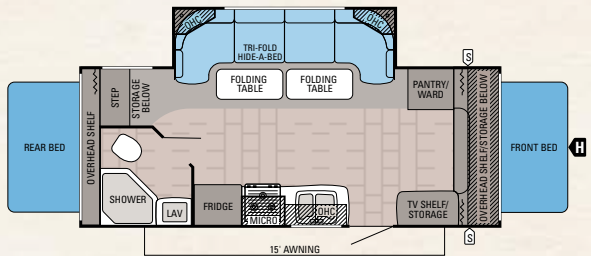

JAY FEATHER ULTRA LITE | X23U

Ext. Length: 24' 10" Ext. Height: 129" Unloaded Wt. (lbs.): 4,640 Sleeps: 5-6

JAY FEATHER ULTRA LITE SPECIFICATIONS

MODELS	DIMENSIONS				WEIGHTS (LBS.)				TANKS (GALS.)			
	FLOORPLAN	EXTERIOR TRAVEL LENGTH	EXTERIOR WIDTH	EXT. HEIGHT (WITH A/C)	INTERIOR HEIGHT	UNLOADED VEHICLE WEIGHT *	DRY HITCH WEIGHT	GROSS VEHICLE WEIGHT RATING	CARGO CARRYING CAPACITY	FRESH (INCLUDES WATER HEATER)	GRAY	BLACK
X17A		18' 7"	96"	116"	78"	2,780	260	3,500	720	28.5	30.5	22.5
X17Z		18' 7"	96"	116"	78"	2,785	340	3,500	715	28.5	30.5	22.5
X18D		20' 9"	96"	121"	78"	3,410	390	4,600	1,190	48	30.5	22.5
X19H		20' 8"	96"	121"	78"	3,320	300	4,950	1,630	48	30.5	22.5
X20E		21' 11"	96"	121"	78"	3,580	350	4,750	1,170	48	30.5	22.5
X213		24'	96"	119"	78"	4,005	390	5,500	1,495	48	30.5	22.5
X23B		24' 5"	96"	119"	78"	3,905	365	4,950	1,045	48	22.5	22.5
X23F		24' 5"	96"	119"	78"	4,170	455	5,995	1,825	48	30.5	22.5
X23U		24' 10"	96"	129"	78"	4,640	545	5,995	1,355	48	30.5	22.5

* The weights of certain options and/or option packages are not included in the UUV listed in the specification charts.

Unloaded Vehicle Weight (UUV): Sometimes referred to as "Dry Weight," UUV means the typical weight of this trailer as built at the factory. The UUV, as used in product literature and other promotional materials, does not include cargo, fresh water, propane, options or dealer-installed accessories.

Gross Vehicle Weight Rating (GVWR): GVWR means the maximum permissible weight of the trailer, including the UUV plus passengers, personal items, all cargo, fluids, options, and dealer-installed accessories. The GVWR is equal to or greater than the sum of the UUV and the CCC.

Cargo Carrying Capacity (CCC): CCC means the maximum weight of all passengers, personal items, food, fresh water, propane, tools, other cargo and dealer-installed accessories that can be carried by the trailer. CCC is equal to or less than GVWR minus UUV. The addition of options will decrease the CCC.

Hitch Weight (HW): The hitch weight, as used in product literature and other promotional materials, does not include cargo, fresh water, propane gas, options or dealer-installed accessories. The addition of these types of items will either add to or subtract from the stated hitch weight.

It is important for your safety and enjoyment that your tow vehicle be adequately sized and equipped to tow and handle the GVWR of the RV you select. Review weights and rating of your tow vehicle and consult a competent advisor for questions or advice. Whether you are new to RVing or a veteran, get a feel for the performance of your tow vehicle before heading out on the roadways. When you tow an RV, you must drive differently than when you drive a single vehicle. Practice hooking up, driving, backing up and braking in a safe environment or seek out professional instruction. Jayco affixes a weight label to each RV which lists weight information for that vehicle. See specifications chart above.

WE START WITH ONE OF THE INDUSTRY'S **strongest** foundations

Jayco builds on custom-sized frames, designed specifically for each floorplan. Other manufacturers use stock frames, stretching and welding the frame to fit.

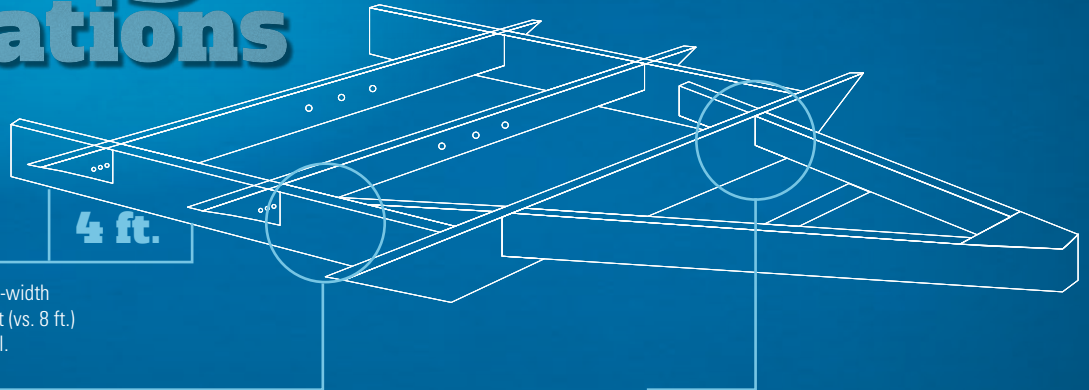

Full-width outriggers: We build on full-width outriggers that are spaced 4-6 feet apart (vs. 8 ft.) to better support the weight of the wall.

Norco NextGen frame: Jay Feather features the industry's strongest strength-to-weight ratio thanks to a Norco NextGen frame made of high-strength, low-alloy sheet steel, huck bolts and an interlocking design (n/a SLX).

Integrated A-frame: The A-frame runs through the main frame, preventing the hitch from buckling like competing tack-welded designs.

– so that we can build the industry's most reliable RV



JAYCO'S ROOF **vs** OTHER ROOFS



4,500 LBS. ON A JAYCO ROOF VS. OTHER ROOFS

THE MAGNUM TRUSS ROOF SYSTEM **50 percent stronger**

In a side-by-side comparison test, Jayco's exclusive Magnum Truss Roof System withstood 4,500 lbs. — 50 percent more than other roofs. The difference?

- ① The walls and floor are vacuum bonded using 15-18 minutes of 144 tons of pressure to ensure a strong bond. (SLX floors feature screwed construction with wood joists.)
- ② Lightweight materials, like welded aluminum frames with metal backers, and Jay Feather's innovative, aerodynamic profile increase towability.
- ③ Extra-wide corner seals on the entry doors, baggage compartment and window seals prevent leaks.
- ④ Jay Feather's water-repellent vinyl tent material resists mildew, mold, scratches and cracks, while the double-stitched design adds strength.
- ⑤ A reversed-cambered support system creates a durable structure rated to hold 1,100 lbs., while a permanent tent-to-bunk attachment system with channel locks eliminates misplaced poles.
- ⑥ The hook tent frame creates more headroom in the bunk area compared to competing tents.
- ⑦ Jayco uses crowned wood trusses, solid-wood studs and oversized nail plates to maximize the roof's load capacity.
- ⑧ Then, we screw down 3/8" roof decking at every seam, a process that is more durable than stapled construction.
- ⑨ Finally, our one-piece, sidewall-wrapped DiFlex II material provides the ultimate in leak protection.



TO SEE THE SIDE-BY-SIDE ROOF
COMPARISON, SCAN HERE WITH
YOUR SMARTPHONE.

WALL CONSTRUCTION **lightweight techniques**

TENT CONSTRUCTION **5-year tent warranty**

JAY FEATHER SLX

STANDARD EXTERIOR EQUIPMENT

TuffShell vacuum-bonded laminated sidewalls, front, rear and end walls
Vacuum-bonded laminated bed platforms with reverse-cambered support (expandables)
Deluxe graphics package with gray exterior fiberglass color
Magnum Truss Roof System
One-piece seamless DiFlex II roof material
Box tube style frames with integrated A-Frame
Amber patio light with interior switch
Heavy-duty entrance step with no-slip treads
G20 dark-tinted windows
Aluminum rims
E-Z Lube axles
Radial tires
Impact-resistant wheel wells
Front diamond plate
Double-wide corner mold extrusions
Radius-cornered entrance and baggage doors
Water-repellent, scratch-resistant vinyl tent material with zipper windows (expandables)
Painted shepherd's hook tent frame (expandables)
Permanently attached tent-to-bed base design (expandables)
Self-supporting, lockable tent ends with 1,100-lb. capacity (expandables)
30-amp service
Stabilizer jacks (2)

STANDARD INTERIOR EQUIPMENT

Screwed-and-glued cabinetry
Ball bearing drawer guides, 75-lb. capacity with full extension
2-burner cooktop range
High-definition laminate countertop with rounded bull-nosed edging
Acrylic sinks with metal plumbing fittings
Plywood dinette, bunk and bed bases
4" high-density dinette cushions
Diamondflor vinyl flooring
8,000-BTU side-mounted air conditioner
Denver Mattress brand bunk mats (expandables)
Full-height shirt wardrobes in front walk-around queen bedroom models
Bathroom roof vent
Bath skylight
Shower curtain (select models)

CUSTOMER VALUE PACKAGE (MANDATORY)

4 cu. ft. Norcold refrigerator
6-gal. gas Atwood water heater
Patio awning
Microwave oven
Pleated shades
Range hood
Spare tire and carrier
AM/FM stereo with MP3 and iPod input
Water heater bypass

OPTIONS

13,500-BTU roof-mounted A/C

INTERIOR DÉCOR CHOICES

JAY FEATHER ULTRA LITE ONLY

STONE

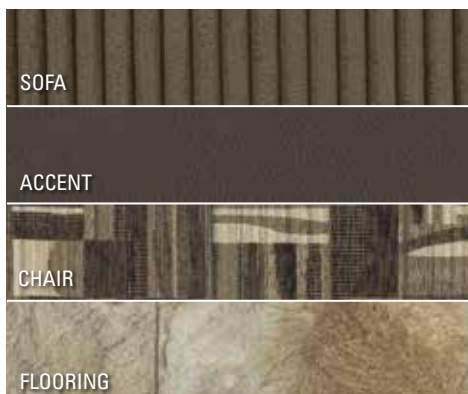

JAY FEATHER ULTRA LITE

STANDARD EXTERIOR EQUIPMENT

TuffShell vacuum-bonded laminated sidewalls, floors, front, rear and end walls
Vacuum-bonded laminated bed platforms with reverse-cambered support (expandables)
Deluxe Graphics Package with gray front and rear walls, slideout endwalls and sidewall color band
.030 bottom radius metal skirting
Magnum Truss Roof System
One-piece seamless DiFlex II roof material
Norco NextGen frame with integrated A-frame
Amber patio lights with interior switch
Entrance step light
Heavy-duty entrance step with no-slip treads
Patio awning (select models)
Marine-grade exterior speakers (2)
G20 dark-tinted windows
E-Z Lube axles
Radial tires
Impact-resistant wheel wells
Black ABS fenders
TorFlex independent torsion-axle suspension (select models)
Aerodynamic, rounded front profile
Front diamond plate
Double-wide corner mold extrusions
Radius-cornered entrance and baggage doors
Knuckle-hinge baggage doors
Electric-powered Schwintek slide systems (select models)
Water-repellent, scratch-resistant vinyl tent material with zipper windows (expandables)
Painted shepherd's hook tent frame (expandables)
Permanently-attached tent-to-bed base design (expandables)
Self-supporting, lockable tent ends with 1,100-lb. capacity (expandables)
Outside grill quick-connect port
Outside shower
Sewer hose storage compartment
Rubberized flexible propane lines
Stabilizer jacks with sand pads (4)
30-amp service

STANDARD INTERIOR EQUIPMENT

Wood-grain accent wall panels (select walls)
Screwed-and-glued cabinetry
Bead-board inserts (select overhead cabinets)
Ball bearing drawer guides, 75-lb. capacity with full extension
5 cu. ft. flush-mounted Norcold refrigerator (select models)

6.3 cu. ft. Norcold double-door refrigerator (select models)
3-burner range with 9,000-BTU SuperBurner and piezo igniter
Oven
High-definition laminate countertop with rounded bull-nosed edging
Deep single-bowl acrylic sink with high-rise faucet (select models)
Large 60/40 acrylic sink with high-rise faucet (select models)
Metal alloy faucet fittings
6-gal. gas/electric DSI Atwood water heater
Plywood dinette, bunk and bed bases
4" high-density dinette cushions
Diamondflor vinyl flooring
Pleated shades throughout with box valances
Cable/satellite hookups
AM/FM/DVD with MP3 and iPod hookups
Denver Mattress brand bunk mats (expandables)
12V power port in tent ends
Bathroom roof vent
Bath skylight
Shower curtain with curved track (select models)

CUSTOMER VALUE PACKAGE

Aluminum rims
ABS bottle cover
Dual 20-lb. propane bottles with regulator
Spare tire with carrier
13,500-BTU air conditioner
Microwave
Water heater bypass

OPTIONS

Enclosed underbelly (n/a X17A and X17Z)
Suspension lift kit (2") (n/a on X23U)
Power Package: Electric awning with LED light and electric tongue jack (n/a X17A and X17Z)
Outside grill
Customer Value Package with 15,000-BTU A/C
Folding table with bench seat (X18D)
22" HDTV (select models)
Tent end bed mat heaters (expandable models)

TRUFFLE

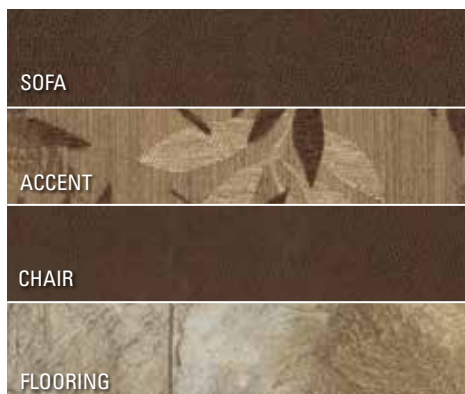

BRICK

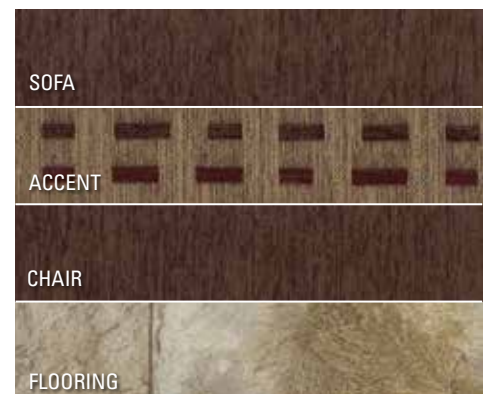

2
YEAR
WARRANTY



Jayco[®]

Generations of family fun.

Bumper-to-hitch limited warranty*

FAMILY fun
starts with peace of mind

FREE Roadside Assistance

At Jayco, we build our RVs to handle every adventure, then we back our products with an industry-leading 2-year limited warranty. You won't find a better warranty in the business because the only strings we attach are those that deliver the ultimate in reliability. That's the Jayco difference. So go explore. We have the warranty that will follow you anywhere.

Travel worry-free with Jayco's Customer First Roadside Assistance program, yours at no cost during the first year of ownership. This program is offered through Coach-Net, the country's largest RV emergency road service, and gives you immediate access to assistance.

*For a copy of our 2-year limited warranty with full terms and conditions, please contact your local Jayco dealer.

eco advantage™

Jayco's long-term commitment to generations of family fun



Scan this QR code with your smartphone to watch a video about our efforts and the impact we're making on our planet.

ecoadvantage.jayco.com

The fun starts with your local Jayco dealer

Your local dealer

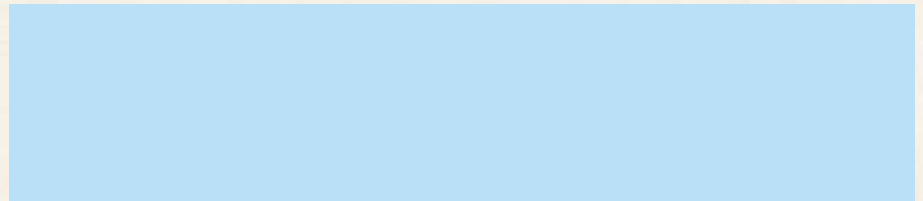

From giving advice to selling and servicing products, we consider our loyal dealers the glue in our family bond. Establishing a solid relationship with your local Jayco dealer is a key component in the enjoyment of your new Jayco. By purchasing from a local dealer, you will have a convenient location for sales, parts and service support. We hope you consider them a part of your camping family.

Follow Jayco



Jayco, Inc., P.O. Box 460, Middlebury, IN 46540, www.jayco.com See dealer for further information and prices. All information in this brochure is the latest available at the time of publication approval. Jayco reserves the right to make changes and to discontinue models without notice or obligation. Photos in this brochure may show optional equipment and props for photography purposes. RVs built for sale in Canada may differ to conform to Canadian codes. ©2014 Jayco, Inc. 15-JFTR-PL 0414-100K Printed in U.S.A.